

La musica è il risultato di suoni combinati, detti Note.
Le note sono sette: DO-RE-MI-FA-SOL-LA-SI.

Esercizio n.1 Esercitati a dire il nome delle note in senso ascendente e in senso discendente.

Senso ascendente:



SENSO DISCENDENTE



ESERCIZIO N.2

COMPLETA LE CASELLE, SCRIVENDO IL NOME DELLE NOTE MANCANTI:

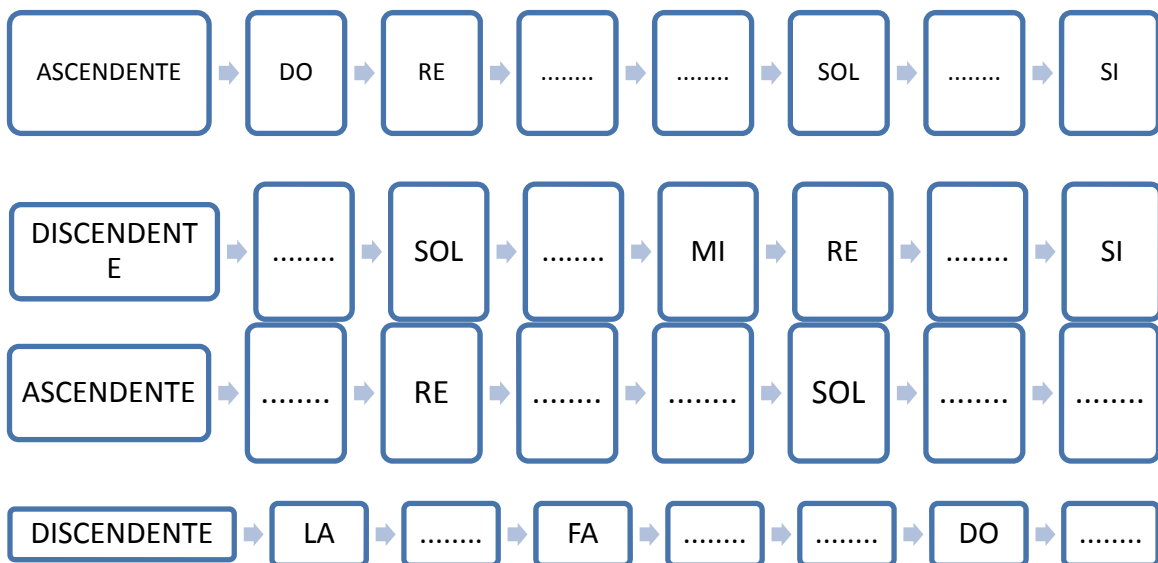

LE NOTE si scrivono sul pentagramma. Il pentagramma è un insieme di 5 linee e 4 spazi.

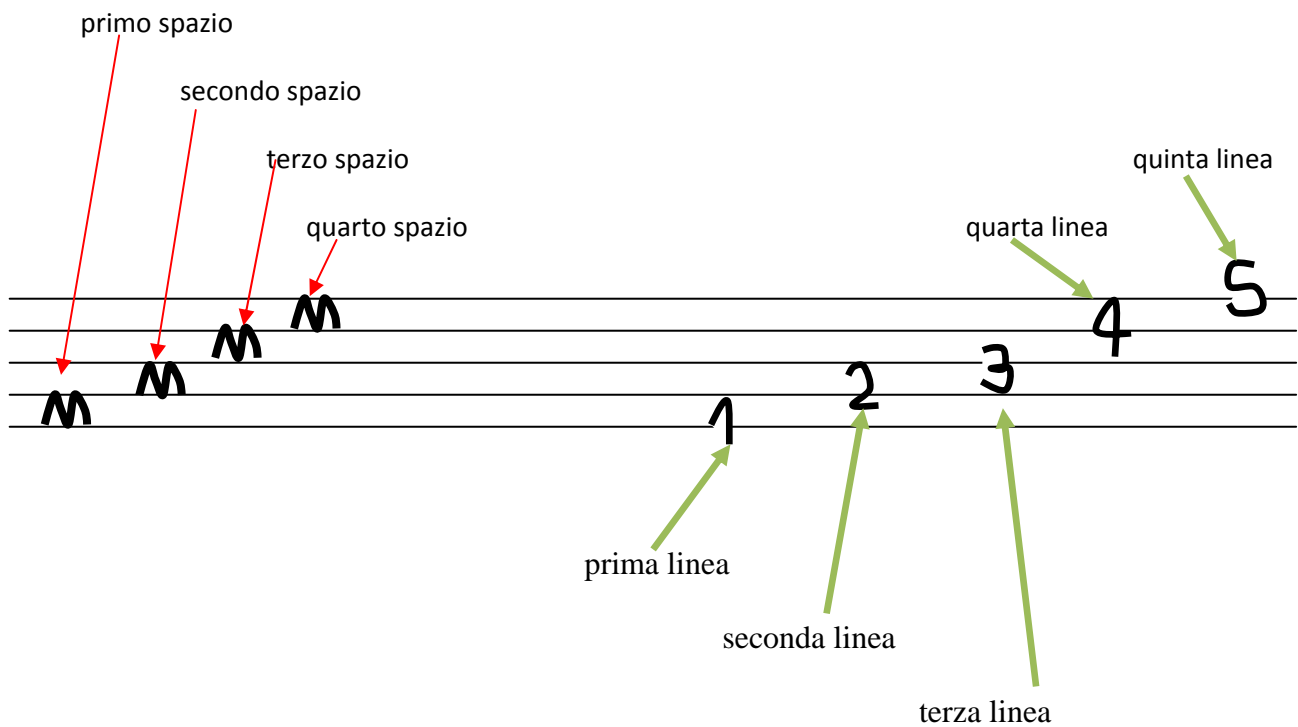

Per suonare il Pianoforte, dobbiamo imparare a leggere le note in chiave di violino e in chiave di basso.

La chiave è un segno grafico posto all'inizio del pentagramma che serve a dare il nome alle note.

1. **La chiave di violino** si appoggia sulla seconda linea. Guarda attentamente come devi tracciarla:

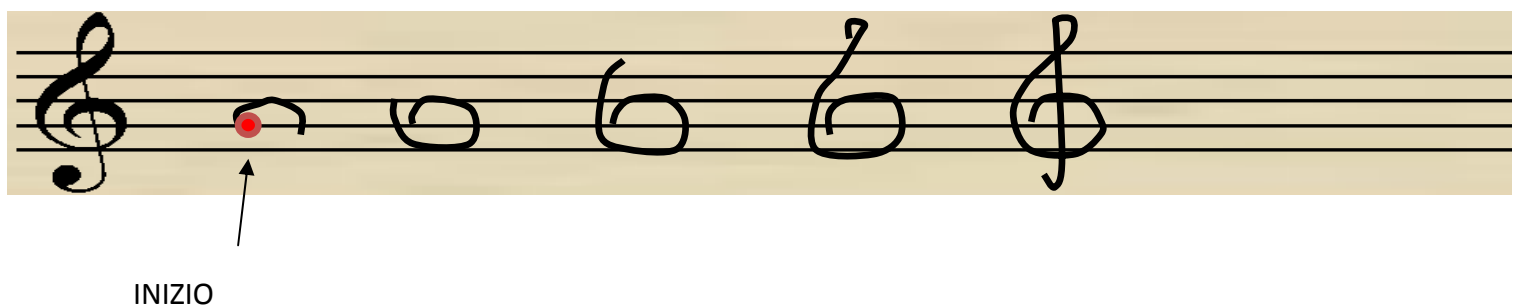

ESERCIZIO N.3

DISEGNA LA CHIAVE DI VIOLINO

2. La chiave di basso si appoggia sulla quarta linea. Guarda attentamente come devi tracciarla:

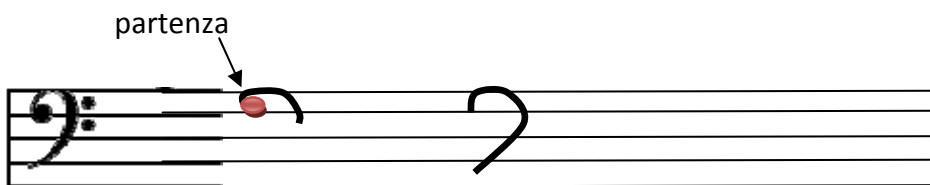

ESERCIZIO N.4

DISEGNA LA CHIAVE DI BASSO.

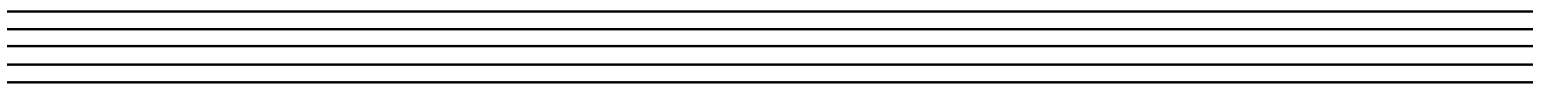



ricopia le note in chiave di violino e leggile tante volte.

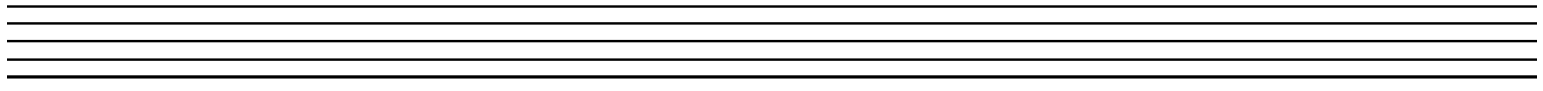
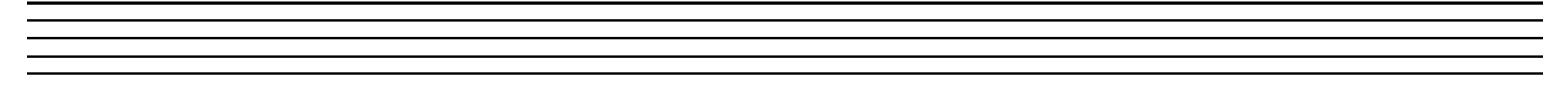
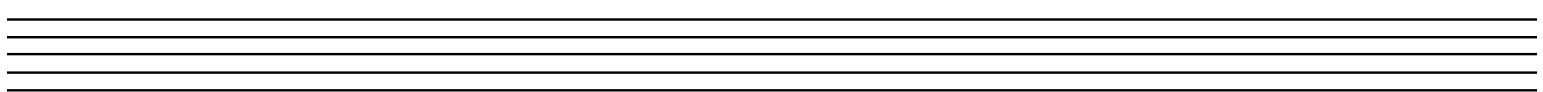
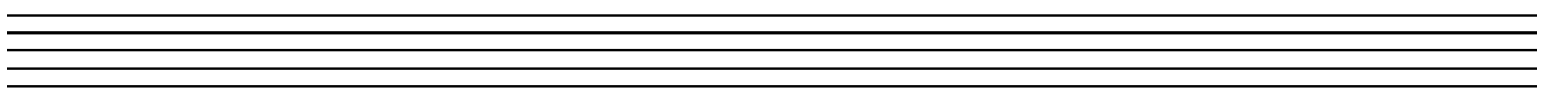
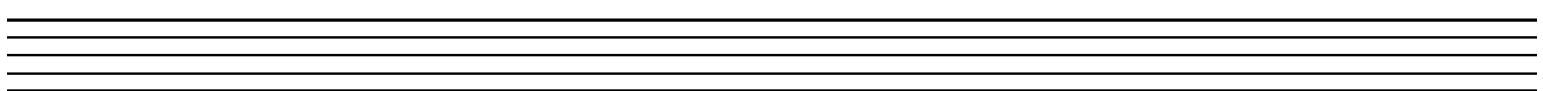
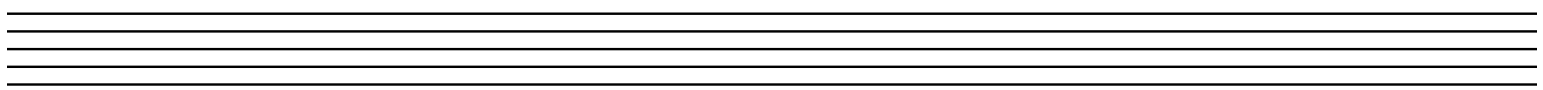



Ricopia le note in chiave di basso e leggile tante volte.

